

General Description

The MR16 LED Driver **Module** Evaluation board shows how to use the new AL8812 with integrated MOSFET in one package as a single stage Boost LED driver for an inexpensive PFC front end for a cost effective MR16 LED Driver circuit from which high PFC (~0.9) can be achieved.

Key Features

- Integrated 60V, 3.6A MOSFET
- Non-Dimmable or Triac Dimmable
- Front end Constant On time PFC circuit using the AL8812 Single Stage Boost LED Driver
- PFC for the 12VAC input allowing multiple MR16 units on one transformer
- Compatible with Electronic Transformers

Applications

- MR16 LED Bulb
- Desktop lamps
- Under the counter lamps

AL8812EV2 Specifications

| Parameter | Value |
|----------------|-------------------------------------|
| Input Voltage | 12VAC |
| LED Current | 350mA (Adjustable) |
| Number of LEDs | 26V LED Array @350mA (Under Tested) |
| XY Dimension | 1.06 " x 0.71" |

Evaluation Board

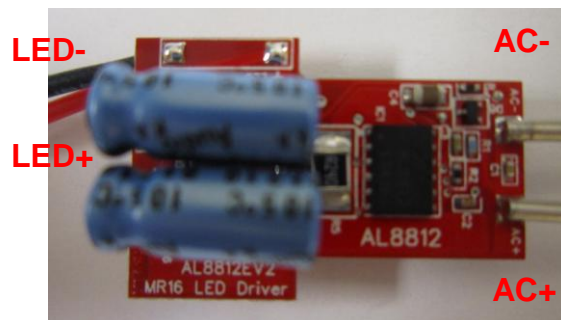

Figure 1: Top View



Figure 2: Bottom View

Connection Instructions

Input Voltage: 12VAC (AC+, AC-)

LED Outputs: LED+ (Red), LED- (Black)

Block Diagram:

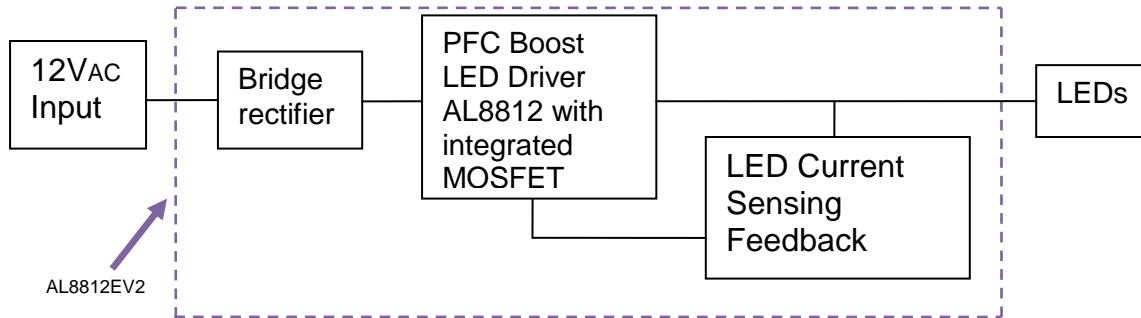

Figure 3: Block Diagram

Evaluation Board Schematic

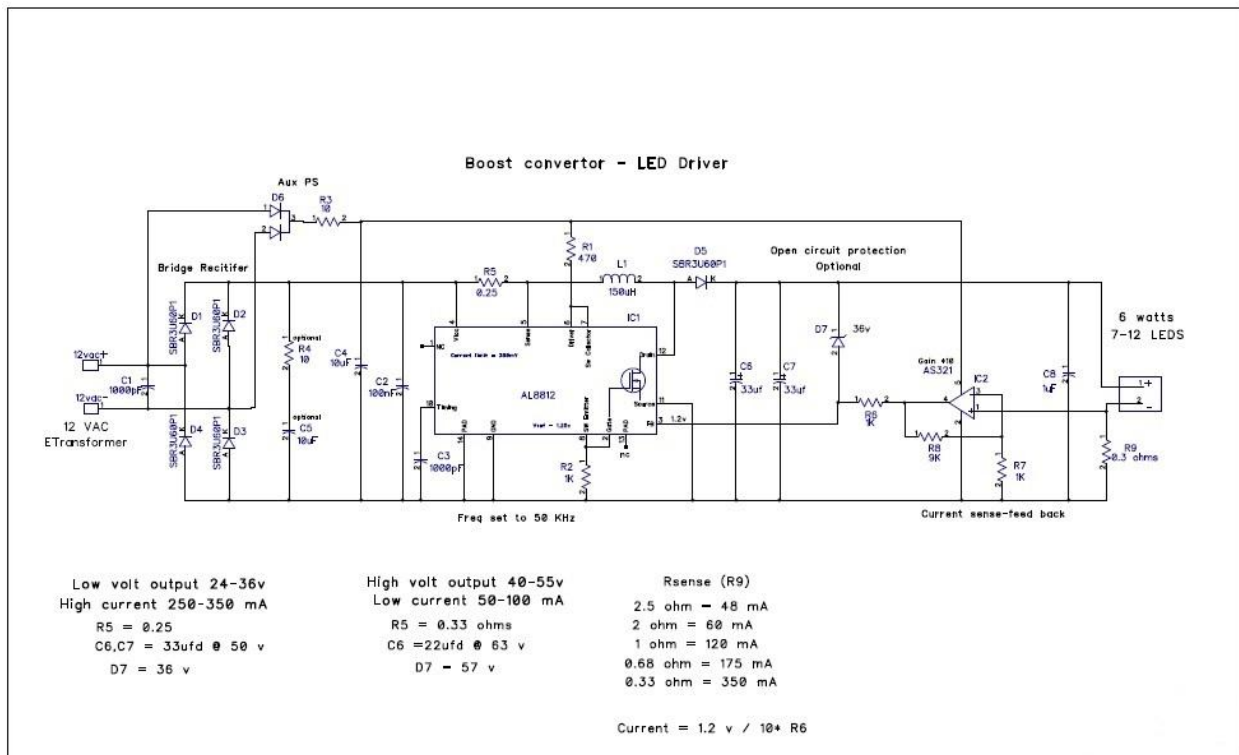

Figure 4: Evaluation Board Schematic

Evaluation Board Layout

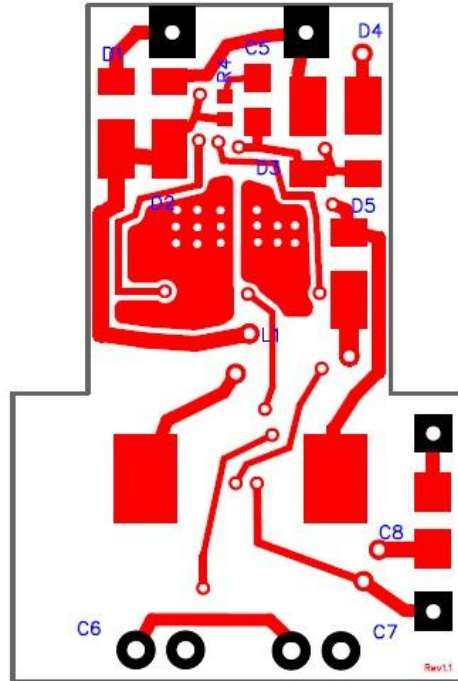

Figure 5: PCB Board Layout Top View

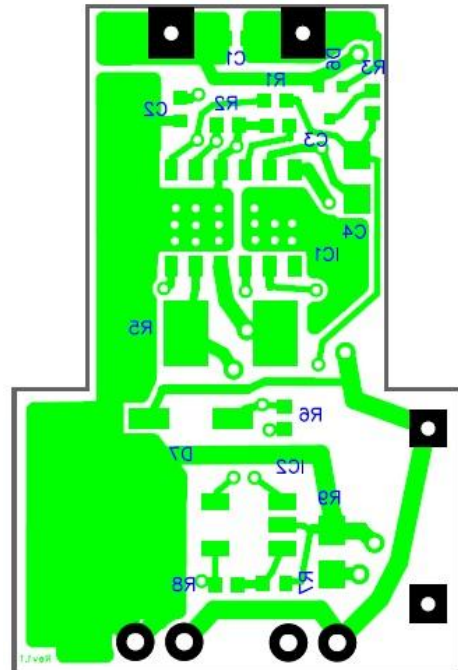

Figure 6: PCB Board Layout Bottom View

Quick Start Guide

1. By default, the evaluation board is preset at 350mA LED Current by R9.
2. Ensure that the AC source is switched OFF or disconnected.
3. Connect the 12Vac AC line wires of power supply to two test points of “12VAC” on the left side of the board.
4. Connect the anode wire of external LED string to LED+ output test point.
5. Connect the cathode wire of external LED string to LED- output test point.
6. Turn on the main switch. LED string should light up.

Bill of Material

| # | Name | Quantity | Part number | Manufacturer | Description |
|----|----------|----------|-------------------------|--------------|------------------------------------|
| 1 | IC1 | 1 | AL8812 | Diodes Inc | Boost IC |
| 2 | IC2 | 1 | AS321KTR-G1 | Diodes Inc | Opamp |
| 3 | D1-D5 | 5 | SBR3U60P1 | Diodes Inc | Super Barrier Rectifiers |
| 4 | D6 | 1 | BAV70-7-F | Diodes Inc | BAV70 Dual diodes |
| 5 | D7 | 1 | DDZ9717S | Diodes Inc | Zener diode – 43 volts |
| 6 | L1 | 1 | 7447714151 | Würth | 150µH, 1.2A Inductor for PFC stage |
| 7 | R1 | 1 | ERJ-2RKF4700X | Panasonic | 470Ω Resistor 1/10W 1% 0402 SMD |
| 8 | R2,R6,R7 | 3 | ERJ-2RKF1001X | Panasonic | 1kΩ Resistor 1/10W 1% 0402 SMD |
| 9 | R3,R4 | 1 | ERJ-2RKF10R0X | Panasonic | 10Ω Resistor 1/10W 1% 0402 SMD |
| 10 | R5 | 1 | RCWE1210R240FKEA | Vishay | 0.24Ω Resistor 1W 1% 1210 SMD |
| 11 | R8 | 1 | ERJ-2RKF9091X | Panasonic | 9.09kΩ Resistor 1/10W 1% 0402 SMD |
| 12 | R9 | 1 | ERJ-3RQFR33V | Panasonic | 0.33Ω Resistor 1/10W 1% 0603 SMD |
| 13 | C1,C3 | 2 | C0402C102J5GACTU | Kemet | 1000pF Cer Cap 50V 5% 0402 SMD |
| 14 | C2 | 1 | C1005X7R1H104K050 BB | TDK | 100nF Cer Cap 50V 10% X7R 0402 |
| 15 | C4,C5 | 2 | C2012X5R1E106K125 AB | TDK | 10µF Cer Cap 25V 10% X5R 0805 |
| 16 | C6,C7 | 2 | UKA1H330MDD1TD | Nichicon | 33µF Aluminum Cap 50V 20% Radial |
| 17 | C8 | 1 | CL21B105KBFNNE | Samsung | 1µF Cer Cap 50V 10% X7R 0805 |

Functional Performance (26V LED array @350mA peak)

| AL8812EV2 Module Board Performance (without dimmer and electronic transformer) | | | | | | | | | | |
|--|------------------------|------------|-----------------|---------|------|----------|------------------|----------|-----------------|----------------|
| Manuf | Board Type | VIN (VRMS) | IIN (IRMS) (mA) | PIN (W) | PF | VLED (V) | ILED (IRMS) (mA) | PLED (W) | ILED Ripple (%) | Efficiency (%) |
| Diodes Inc | AL8812EV2 Module Board | 12 | 777.3 | 8.29 | 0.89 | 25.92 | 249.4 | 6.46 | 8 | 77.95 |

Functional Waveforms

For 120VAC dimmable MR16 design bench testing:

The electronic transformer type is Hatch RS12-150 / 150W.

The dimmer type is Lutron SELV-300P.

Following is a block diagram of the bench circuit that indicates voltage and current designations where the scope plots are functionally captured on the bench set-up. The bench set-up is used in the evaluation of the AL8812EV2 module dimmable MR16 design.

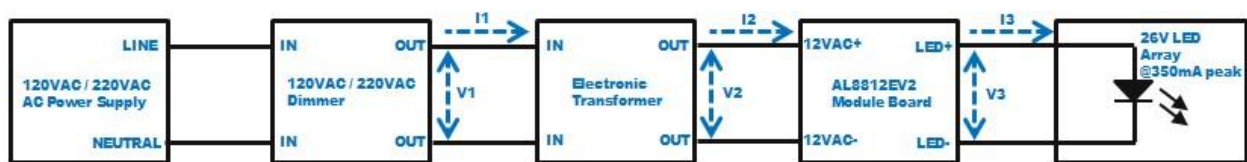
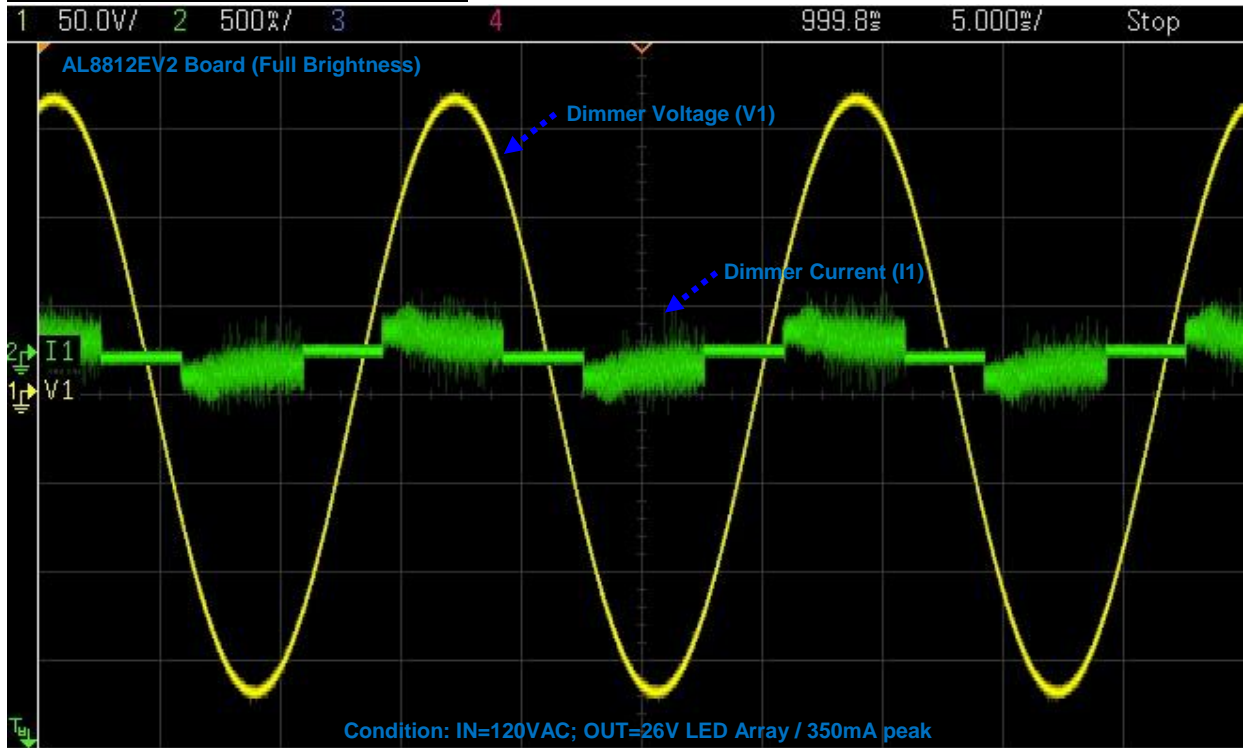
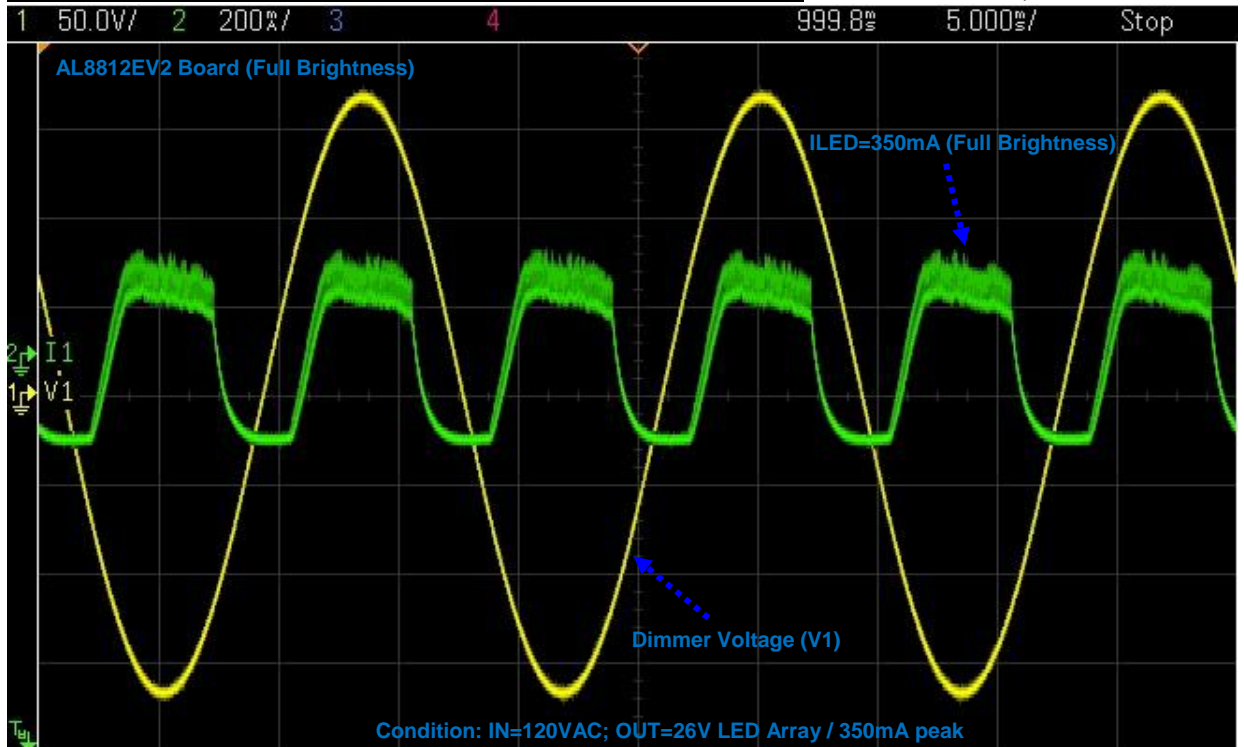

Figure 7: Bench Set-up Circuit

Waveform #1 (Maximum Dimming) => Channel 1: V1; Channel 2: I1



Waveform #2 (Dimming Control ILED=350mA full brightness) => Channel 1: V1; Channel 2: I1



Waveform #3 (Dimming Control ILED=250mA) => Channel 1: V1; Channel 2: I1

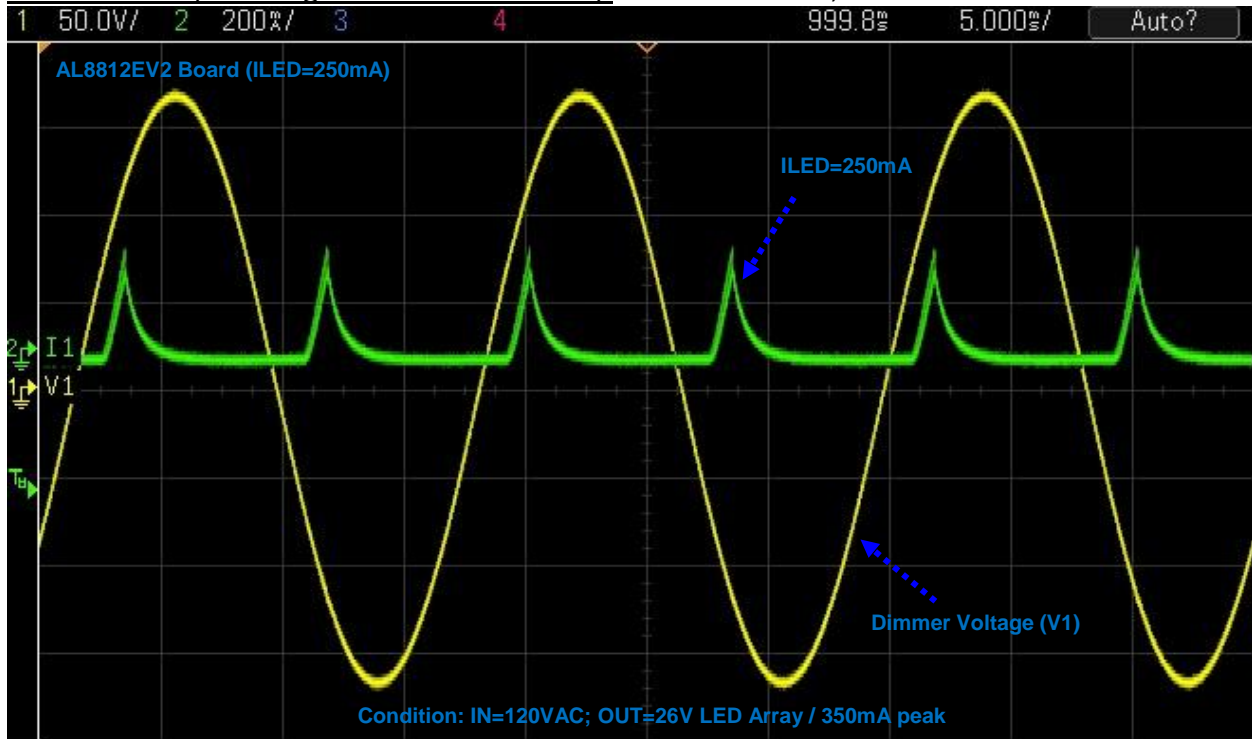

Waveform #4 (Dimming Control ILED=135mA Lowest Brightness) => Channel 1: V1; Channel 2: I1

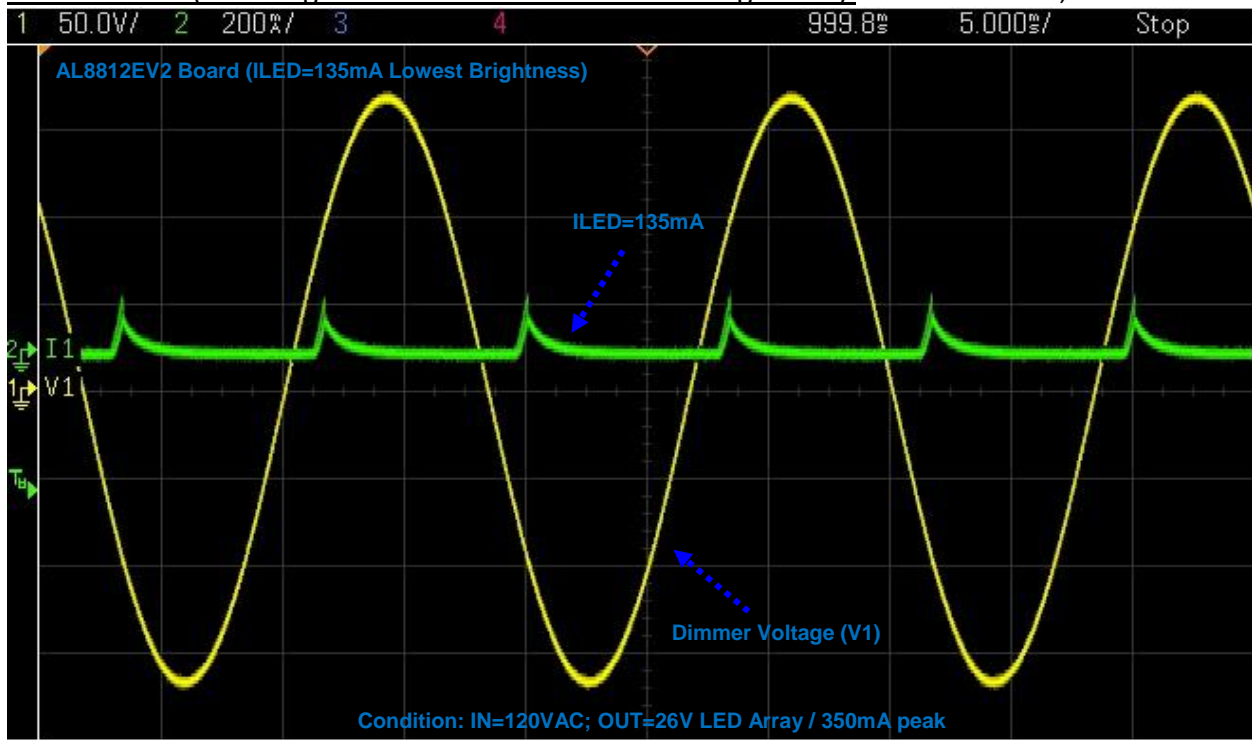

Waveform #5 (Maximum Dimming) => Channel 1: V2; Channel 2: I2

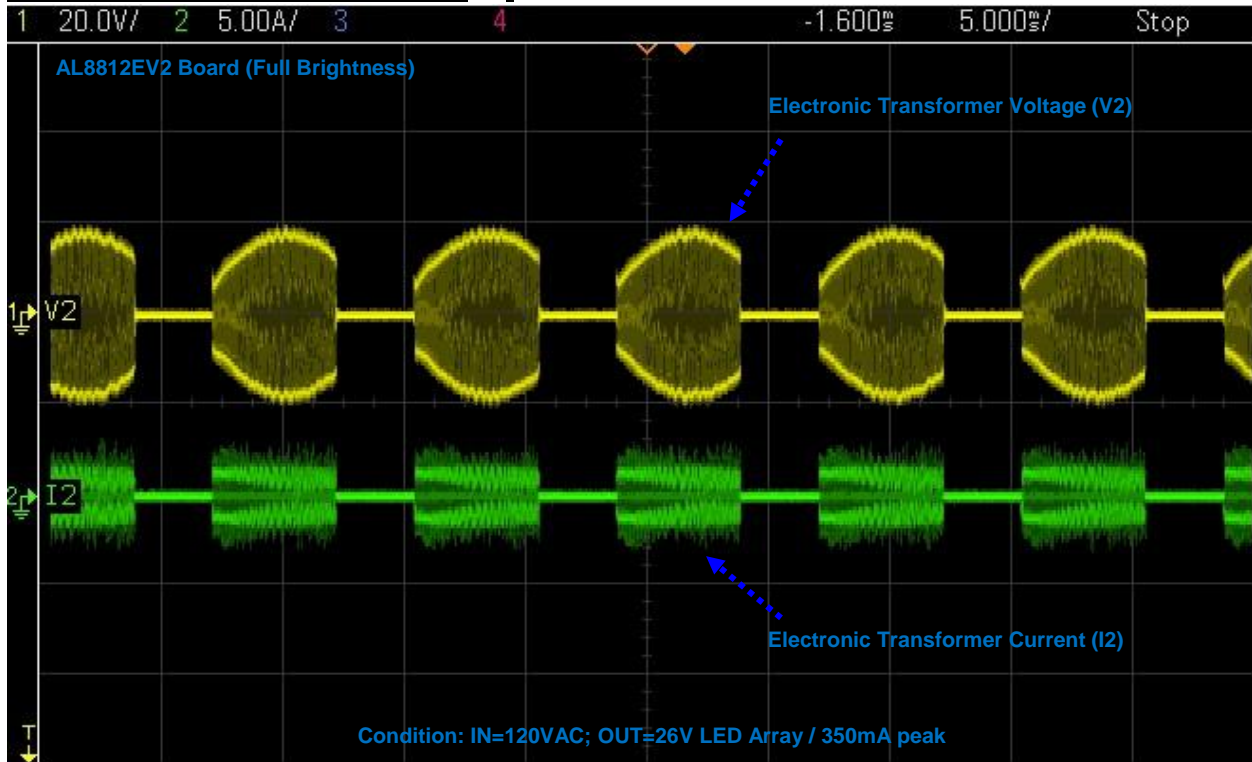

Waveform #6 (Zoom-in for Maximum Dimming) => Channel 1: V2; Channel 2: I2

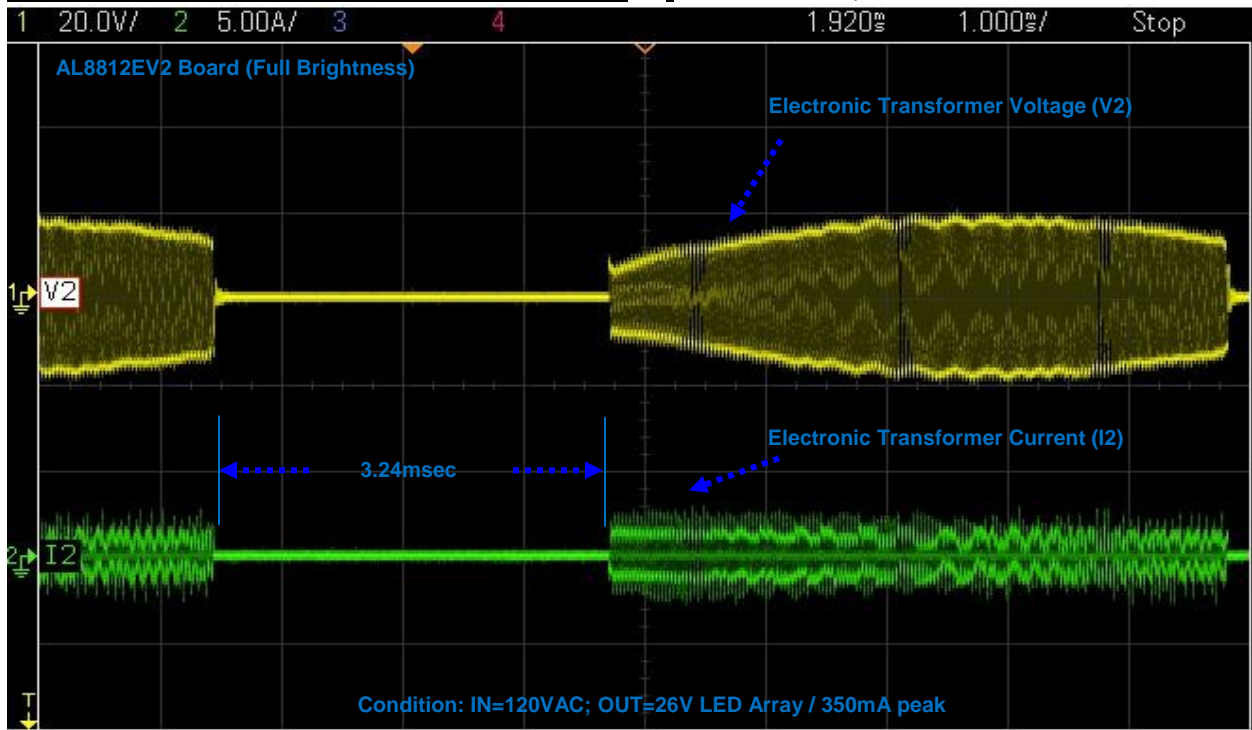

Waveform #8 (Dimming Control full brightness) => Channel 2: I2; Channel 3: I3

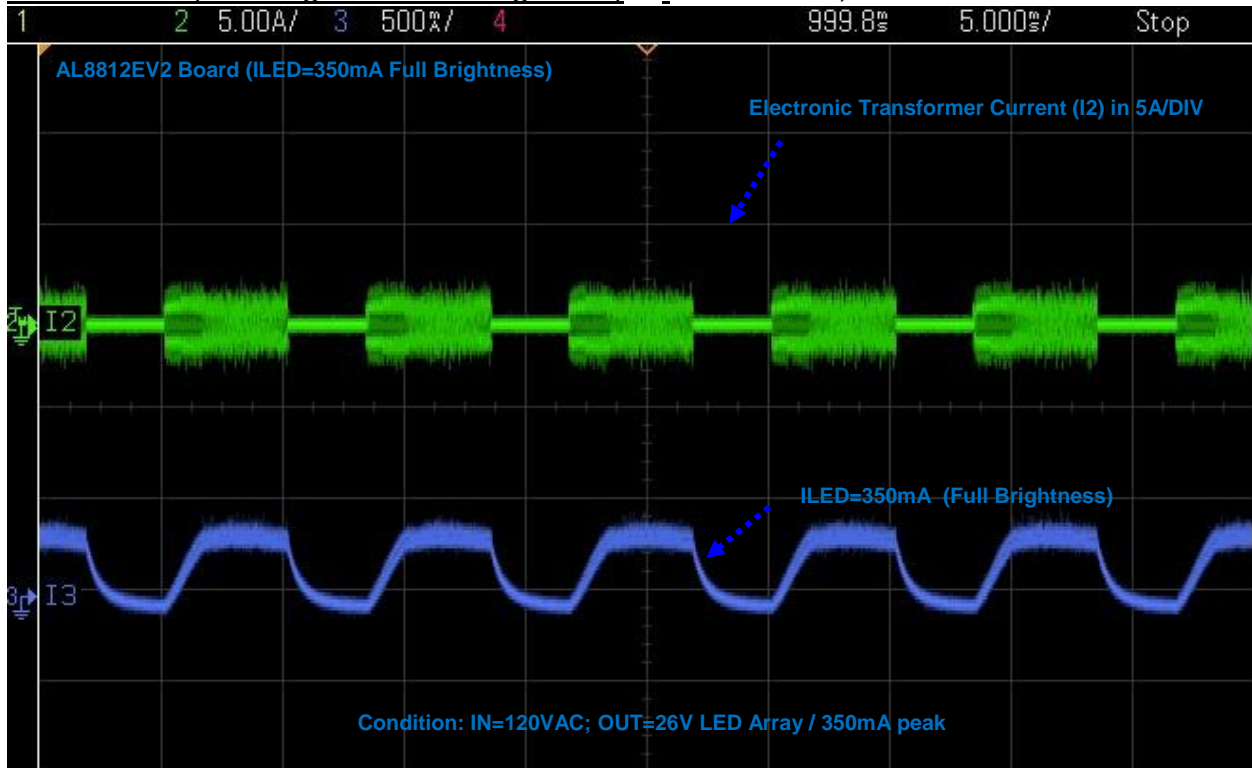

Waveform #10 (Dimming Control ILED=250mA) => Channel 2: I2; Channel 3: I3

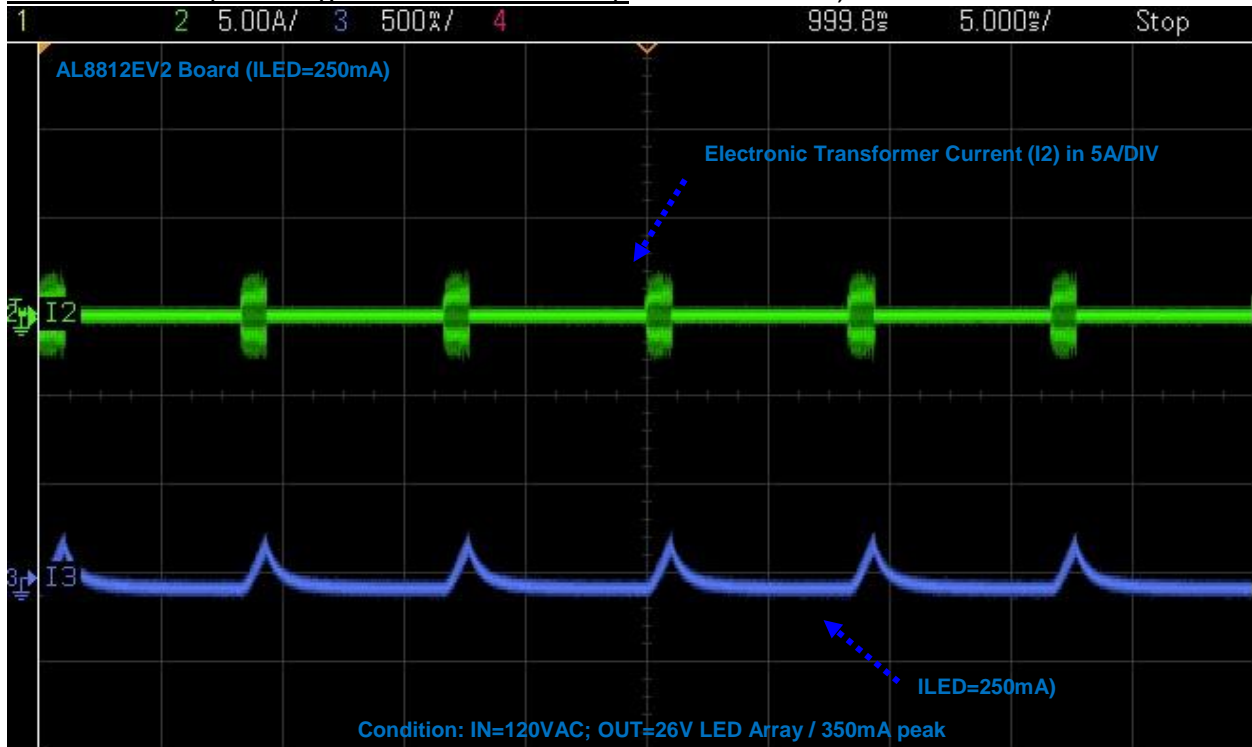

Waveform #11 (Dimming Control ILED=26mA Lowest Brightness) => Channel 2: I2; Channel 3: I3

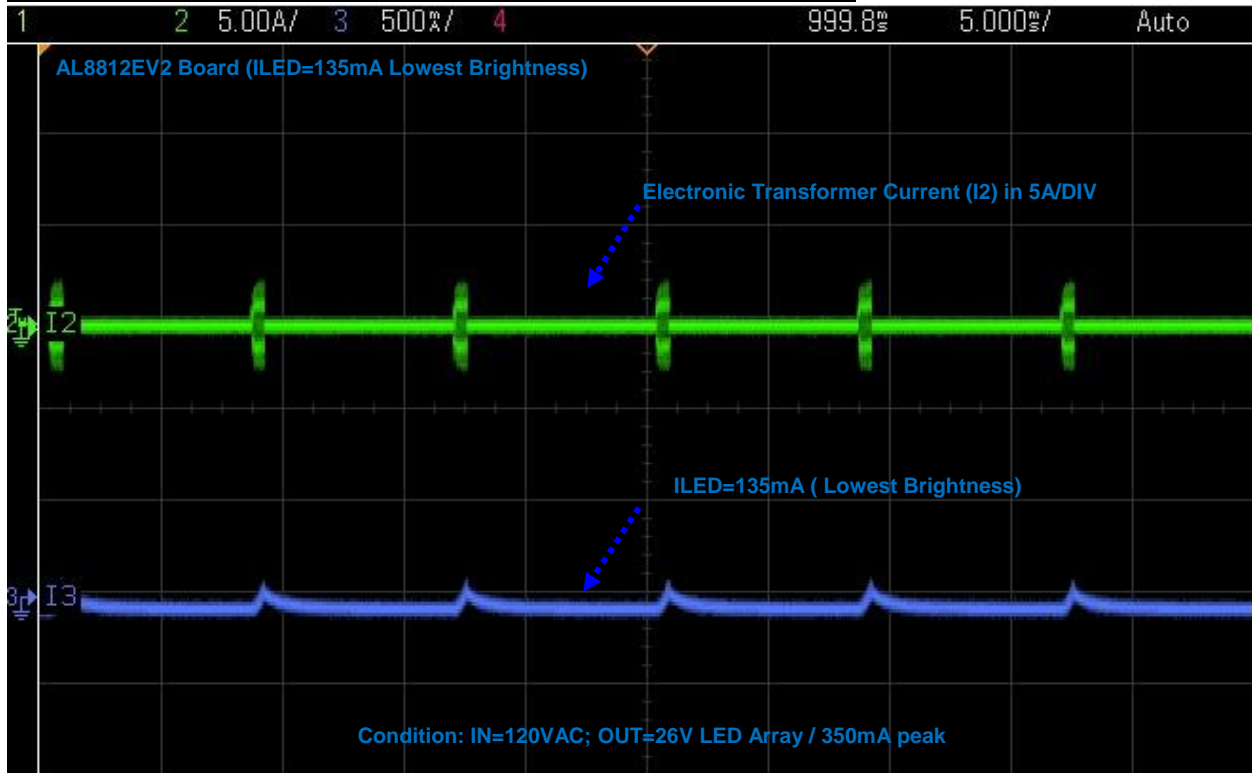

Waveform #12 (Maximum Dimming) => Channel 1: V2; Channel 2: I2; Channel 3: I3

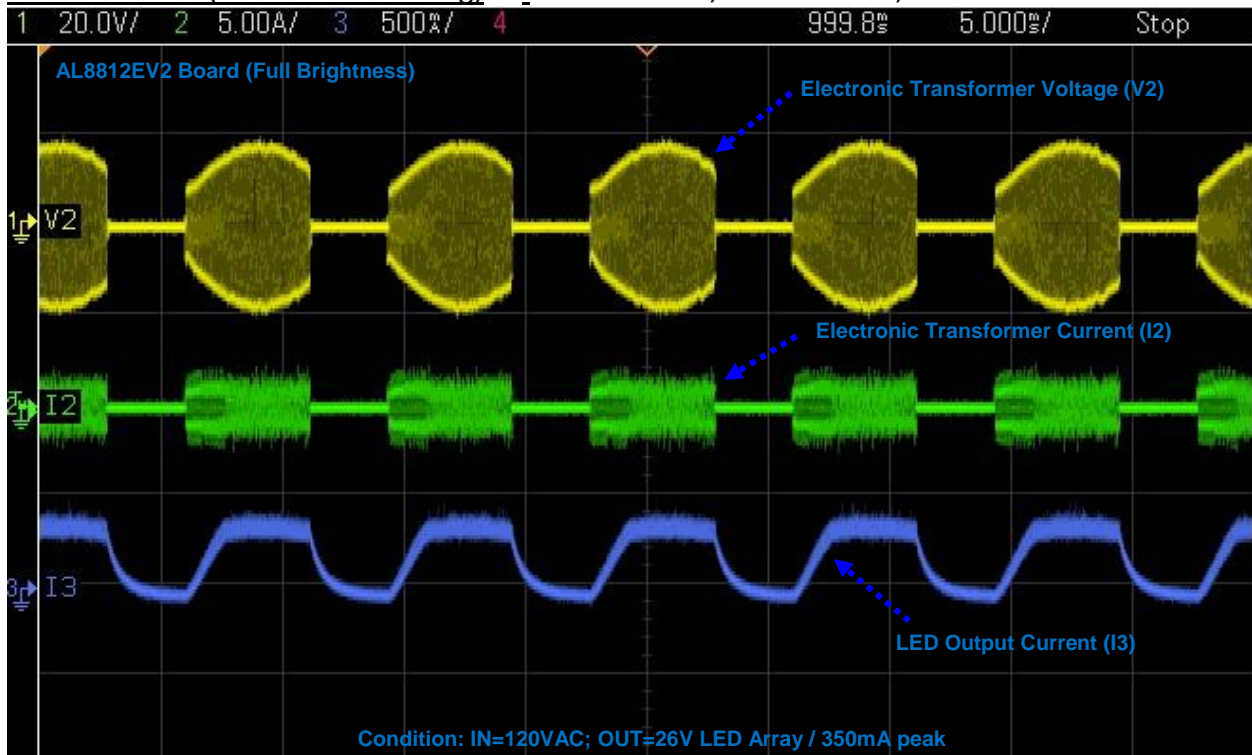

Waveform #13 (Maximum Dimming) => Channel 3: I3; Channel 1: V3

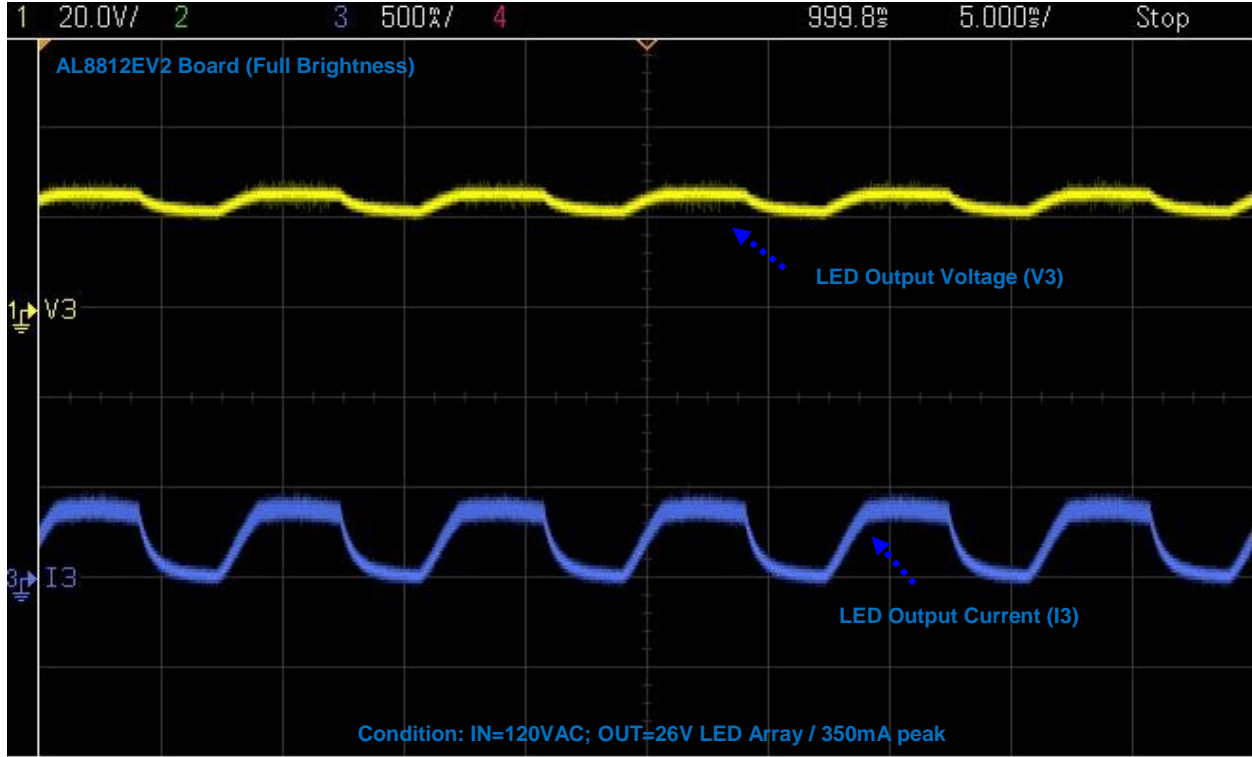

Functional Data Curves

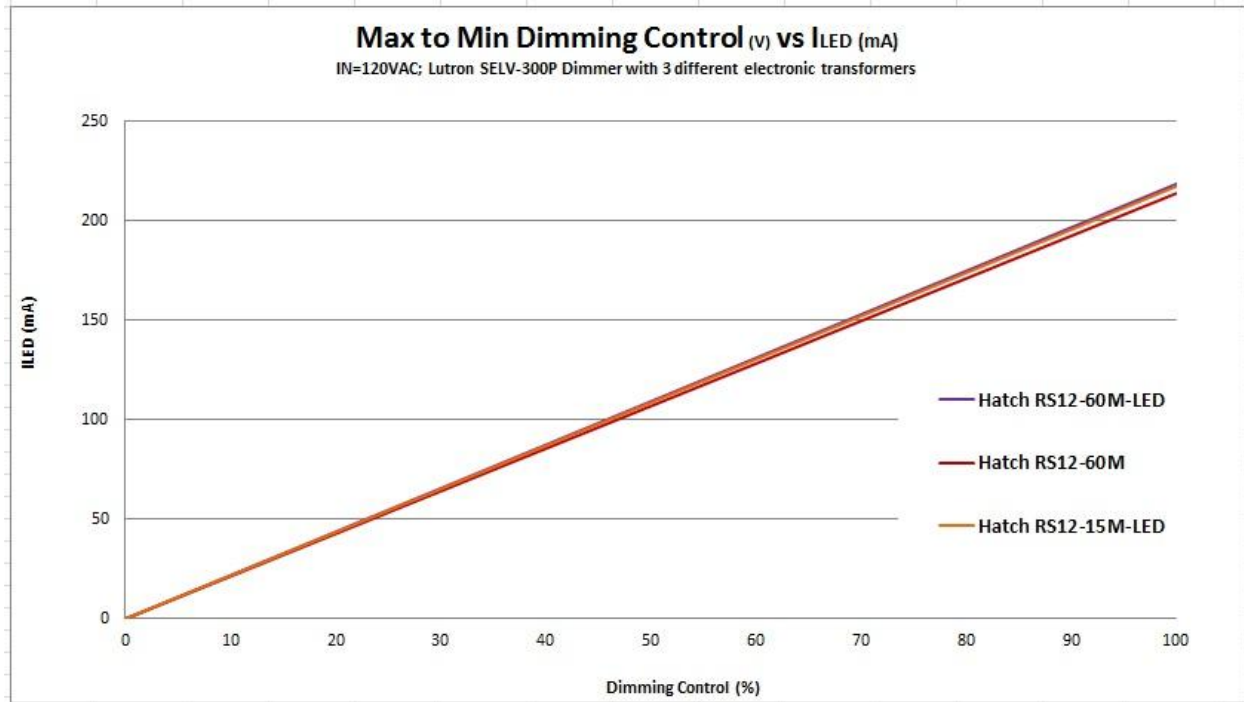

Transformer Compatibility List

1) 120VAC to 12VAC Electronic Transformers without dimmers in 1 (26V) LED array:

| Index | Electronic Transformers (120VAC to 12VAC) | | Performance Result (No flicker) |
|-------|--|--------------------|------------------------------------|
| | Brand | Model | |
| 1 | RSA | RT60A (60W) | ✓ |
| 2 | HATCH | RS12-150 (150W) | ✓ |
| 3 | HATCH | RS12-60M-LED (60W) | ✓ |
| 4 | HATCH | RS12-60M (60W) | ✓ |
| 5 | HATCH | RS12-80M (80W) | ✓ |
| 6 | HATCH | RS12-105 (105W) | ✓ |
| 7 | HATCH | RS12-15M-LED (15W) | ✓ |

2) 120VAC to 12VAC Electronic Transformers with dimmers in 1 (26V) LED array:

| Index | Electronic Transformers (120VAC to 12VAC) | | 120VAC Dimmer Type | |
|-------|--|--------------------|----------------------------|----------------------------|
| | Brand | Model | LUTRON SELV-300P / 300W | LUTRON MAELV-600 / 600W |
| 1 | HATCH | RS12-60M-LED (60W) | ✓ | ✓ |
| 2 | HATCH | RS12-60M (60W) | ✓ | ✓ |
| 3 | HATCH | RS12-15M-LED (15W) | ✓ | ✓ |

Note: ✓ = No Flicker

Application Information

Circuit Description

This design consists of three sections:

- 1) The input boost circuit converts the 12V_{AC} input voltage to a DC voltage around 26V (AL8812).
- 2) The open circuit protection circuitry.
- 3) Finally, the LED current sense circuit generates a voltage to feedback the boost converter.

Boost Circuit

The AL8812 Boost converter is a simple “Constant ON time controller”. By keeping the same ON time throughout the AC cycle, the circuit will draw a current that will closely match the voltage and result in a constant input current. This eliminates the classic peak current problem with a bridge rectifier and a large input filter capacitor.

The boost circuit includes the input bridge rectifier, EMI filter (if needed) and the AL8812 Boost converter. The AC input voltage is rectified by the bridge circuit and filtered by C1, R4, C2, and C5. This first filter removes the high frequency that is generated by the Electronic Transformer in the range of 20-30 KHz. An additional diode rectifier circuit (D6, C4) is used to generate a voltage that is used to power the circuit that will turn on/off the internal MOSFET of the Boost converter and to power the operational amplifier in the LED current sense feedback circuitry.

The AL8812 has a current limit resistor R5 which sets the maximum current allowed through the inductor L1. The output voltage is set to around 26 volts and filtered by the two capacitors C6 and C7. These two capacitors store energy that will be used when the input voltage is low during the AC cycle.

Open Circuit Protection:

This circuit is used to limit the output voltage from going above the voltage limit of the output capacitors (C8) if the LED string is disconnected. In this example, a 35 volt output capacitor would be a good choice so the output maximum voltage would be around 30 volts. The output overvoltage is equal to the zener diode (D7) voltage plus the 1.2 volt threshold of the boost feedback pin. Note be aware that zener diodes have a typical range of +/- 2 volts.

$$\text{Overvoltage} = 30\text{v (zener voltage)} + 1.2\text{ v}$$

Overvoltage protection range from 28 volts to 32 volts

LED Current sense circuit:

The current thru the LED is set with the LED sense resistor (R9). This control voltage is applied to the feedback node of the boost converter. When the voltage on the feedback pin is over 1.2 volts, the boost converter will turn off. To keep the power dissipated in this resistor small, the voltage is amplified by an amplifier with a gain of 10 reducing the resistance by 10.

The current in the LED string is:

$$R_{\text{sense}} (R9) = \frac{1.2 \text{ v}}{10 * \text{LED Current (amps)}}$$

For a LED string current of 0.5 amps:

$$R_{\text{sense}} = 1.2 \text{ v} / (10 * 0.5) = 0.25 \text{ ohms} \quad (\text{SMD 0603 resistor})$$

Setting the Boost Variables (AL8812)

The choice for the size of the boost converter inductor selected in this design is based on a compromise which it is able to support a peak current to around 1.5A since the average input voltage will be around 12-14V.

The boost converter (AL8812) includes a current limit resistor R5 which will limit the current through the inductor and thus the power delivered to the output load. The formula for the resistor is:

$$I_{\text{PK}(\text{switch})} = 0.25\text{V} / R5$$

For a current limit of 1A, R5 is 0.25Ω.

In this evaluation design, this value was selected based on having eight LEDs in series drawing about 350mA. It was found that two 33μF capacitors mounted in parallel would just fit into the cavity of the MR16 bulb.

Performance Description

The evaluation board allows the testing of different combinations of circuit component values to match the final design specifications. The main design goal is to have a constant load on the Electronic Transformer so that it will be operating throughout the AC cycle. This is accomplished when the input power is about the same as the output power.

Overall, there are three major components that are essential to the operation of the circuit.

The first component to select is the resistor (R9) in the LED current sense circuit that sets the final current through the LED string. This will set the amount of power the system needs.

The second component is the value of the (R5) which limits the current provided to the output filter capacitors. This should be adjusted so that the boost input circuit by AL8812 LED driver is always running and thus providing a load to the Electronic Transformer. This usually means that the output voltage of the boost circuit will have a large ripple. This will be okay as long as the lowest voltage is higher than the maximum final LED string voltage.

The third component is the output capacitors (C6 and C7) of the boost circuit. These should not be too large that the PFC circuit stops working. If it happens, the resonant circuit of the Electronic Transformer will become erratic and cause the LEDs to flicker.

IMPORTANT NOTICE

DIODES INCORPORATED MAKES NO WARRANTY OF ANY KIND, EXPRESS OR IMPLIED, WITH REGARDS TO THIS DOCUMENT, INCLUDING, BUT NOT LIMITED TO, THE IMPLIED WARRANTIES OF MERCHANTABILITY AND FITNESS FOR A PARTICULAR PURPOSE (AND THEIR EQUIVALENTS UNDER THE LAWS OF ANY JURISDICTION).

Diodes Incorporated and its subsidiaries reserve the right to make modifications, enhancements, improvements, corrections or other changes without further notice to this document and any product described herein. Diodes Incorporated does not assume any liability arising out of the application or use of this document or any product described herein; neither does Diodes Incorporated convey any license under its patent or trademark rights, nor the rights of others. Any Customer or user of this document or products described herein in such applications shall assume all risks of such use and will agree to hold Diodes Incorporated and all the companies whose products are represented on Diodes Incorporated website, harmless against all damages.

Diodes Incorporated does not warrant or accept any liability whatsoever in respect of any products purchased through unauthorized sales channel.

Should Customers purchase or use Diodes Incorporated products for any unintended or unauthorized application, Customers shall indemnify and hold Diodes Incorporated and its representatives harmless against all claims, damages, expenses, and attorney fees arising out of, directly or indirectly, any claim of personal injury or death associated with such unintended or unauthorized application.

Products described herein may be covered by one or more United States, international or foreign patents pending. Product names and markings noted herein may also be covered by one or more United States, international or foreign trademarks.

This document is written in English but may be translated into multiple languages for reference. Only the English version of this document is the final and determinative format released by Diodes Incorporated.

LIFE SUPPORT

Diodes Incorporated products are specifically not authorized for use as critical components in life support devices or systems without the express written approval of the Chief Executive Officer of Diodes Incorporated. As used herein:

A. Life support devices or systems are devices or systems which:

1. are intended to implant into the body, or
2. support or sustain life and whose failure to perform when properly used in accordance with instructions for use provided in the labeling can be reasonably expected to result in significant injury to the user.

B. A critical component is any component in a life support device or system whose failure to perform can be reasonably expected to cause the failure of the life support device or to affect its safety or effectiveness.

Customers represent that they have all necessary expertise in the safety and regulatory ramifications of their life support devices or systems, and acknowledge and agree that they are solely responsible for all legal, regulatory and safety-related requirements concerning their products and any use of Diodes Incorporated products in such safety-critical, life support devices or systems, notwithstanding any devices- or systems-related information or support that may be provided by Diodes Incorporated. Further, Customers must fully indemnify Diodes Incorporated and its representatives against any damages arising out of the use of Diodes Incorporated products in such safety-critical, life support devices or systems.

Copyright © 2014, Diodes Incorporated

www.diodes.com